

M63 • M71 • M80

Motori elettrici in corrente continua / D.C. Electric motors



M63-B3



M71-B34



M80-B5

DESCRIZIONE E APPLICAZIONI

Motori elettrici in corrente continua 12V e 24V a magneti permanenti largamente utilizzati per applicazioni con ventilatori, pompe, compressori, impianti frigoriferi, verricelli, trazione, sollevamento e riduttori di velocità. **N.B.: a richiesta disponibili altre tensioni (36V, 48V etc.).**

DESCRIPTION AND USE

Permanent magnets electric motors made in D.C. 12V and 24V widely used for application with blowers, pumps, air compressors, cooling plants, windlasses, traction, lifting and gearbox. **Note: other voltages available on request (36V, 48V etc.).**

CARATTERISTICHE TECNICHE

Motore elettrico a magneti permanenti, protezione IP23-IP44 (IP 55 e IP 65 a richiesta), Classe di Isolamento F, Servizio continuo (S1) o Servizio intermittente (S2).

TECHNICAL FEATURES

D.C. permanent magnets electric motor, protection IP23-IP44 (IP55 and IP65 on request), Insulation class F, Continuous Duty (S1) or short time duty (S2).

FORME COSTRUTTIVE

B3-B34-B35: con piedini
B5-B14: senza piedini

SHAPES

B3-B34-B35: with feet
B5-B14: without feet

ACCESSORI A RICHIESTA

Morsettiera

ACCESSORIES ON REQUEST

Terminal board connection

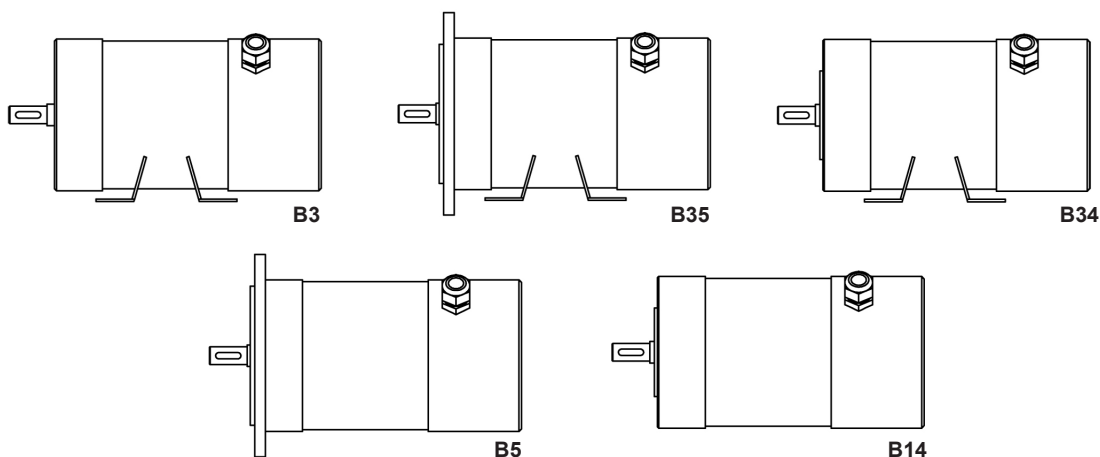

PRESTAZIONI / PERFORMANCES

Modello Type	Forme costruttive Shapes	Voltaggio Voltage (V)	1400 rpm		2000 rpm		2800 rpm	
			Potenza / Power (kW)	Amperes (A)	Potenza / Power (kW)	Amperes (A)	Potenza / Power (kW)	Amperes (A)
M63.H50	B3 / B34 / B35 B5 / B14	12	0,03	2,9	0,05	5	0,07	7
		24	0,03	1,5	0,05	2,5	0,07	3,5
M63.H75	B3 / B34 / B35 B5 / B14	12	0,05	4,9	0,08	7,5	0,1	10
		24	0,05	2,5	0,08	3,8	0,1	5
M63.H100	B3 / B34 / B35 B5 / B14	12	0,08	7,5	0,11	11	0,15	15
		24	0,15	3,8	0,22	11	0,3	15
M71.H70	B3 / B34 / B35 B5 / B14	12	0,3	30	0,35	35	0,4	40
		24	0,3	15	0,35	17,5	0,4	20
M71.H100	B3 / B34 / B35 B5 / B14	12	0,45	40	0,5	50	0,55	54
		24	0,45	20	0,5	25	0,55	27
M71.H120	B3 / B34 / B35 B5 / B14	12	0,5	50	0,6	60	0,65	64
		24	0,75	37	0,8	40	0,95	49
M80.H100	B3 / B34 / B35 B5 / B14	12	0,45	40	0,5	50	0,55	54
		24	0,45	20	0,5	25	0,55	27
M80.H120	B3 / B34 / B35 B5 / B14	12	0,5	50	0,6	60	0,65	64
		24	0,75	37	0,8	40	0,95	49
M80.H140	B3 / B34 / B35 B5 / B14	12	0,55	54	0,6	60	0,65	64
		24	0,8	40	1	50	1,3	64

12-24V: CORRENTE CONTINUA / DIRECT CURRENT

B3 - B34 - B35: con piedi / with feet

B5 - B14: senza piedi / without feet

DIMENSIONI E PESI / DIMENSIONS AND WEIGHTS

M63 / B3

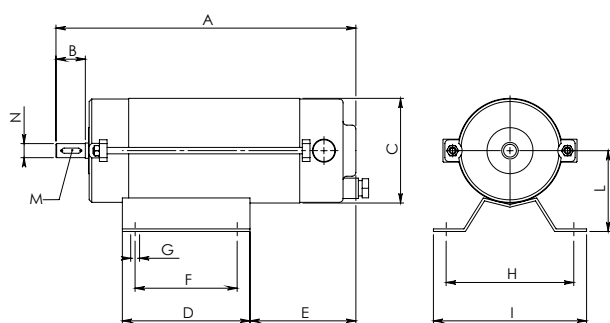

M71 / B3 - M80 / B3

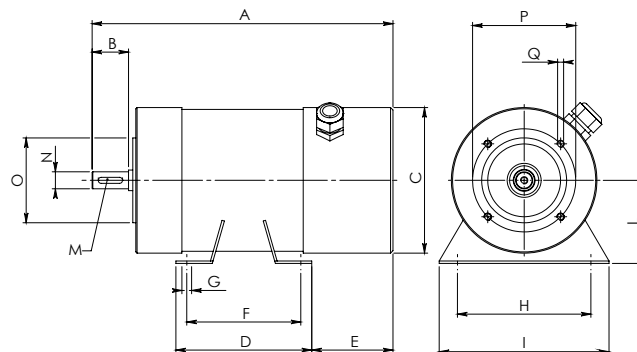

Modello Type	A	B	C	D	E	F	G	H	I	L	M	N	Peso Weight (kg)
M63.H50 / B3	200	23	80	100	45	80	7	100	120	63	4x15	11	3
M63.H75 / B3	225	23	80	100	70	80	7	100	120	63	4x15	11	3,5
M63.H100 / B3	250	23	80	100	95	80	7	100	120	63	4x15	11	4
M71.H70 / B3	250	30	117	110	70	90	8	112	140	71	5x20	14	7
M71.H100 / B3	300	30	117	110	120	90	8	112	140	71	5x20	14	9
M71.H120 / B3	300	30	117	110	120	90	8	112	140	71	5x20	14	10
M80.H100 / B3	300	40	117	125	120	100	9	125	160	80	6x30	19	9,5
M80.H120 / B3	300	40	117	125	120	100	9	125	160	80	6x30	19	10,5
M80.H140 / B3	320	40	117	125	140	100	9	125	160	80	6x30	19	12

Misure in millimetri (mm), dimensioni non impegnative / Measures in millimeter (mm), dimensions approximated

M63 • M71 • M80

Motori elettrici in corrente continua / D.C. Electric motors

DIMENSIONI E PESI / DIMENSIONS AND WEIGHTS

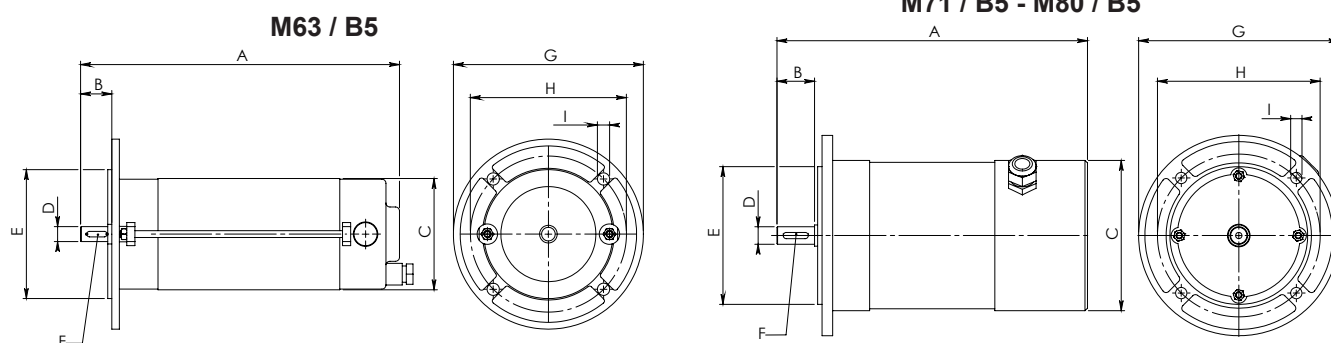

Modello Type	A	B	C	D	E	F	G	H	I	Peso Weight (kg)
M63.H50 / B5	200	23	80	11	95	4x15	140	115	9,5	3
M63.H75 / B5	225	23	80	11	95	4x15	140	115	9,5	3,5
M63.H100 / B5	250	23	80	11	95	4x15	140	115	9,5	4
M71.H70 / B5	250	30	117	14	110	5x20	160	130	9,5	7
M71.H100 / B5	300	30	117	14	110	5x20	160	130	9,5	9
M71.H120 / B5	300	30	117	14	110	5x20	160	130	9,5	10
M80.H100 / B5	300	40	117	19	130	6x30	200	165	11,5	9,5
M80.H120 / B5	300	40	117	19	130	6x30	200	165	11,5	10,5
M80.H140 / B5	320	40	117	19	130	6x30	200	165	11,5	12

Misure in millimetri (mm), dimensioni non impegnative / Measures in millimeter (mm), dimensions approximated

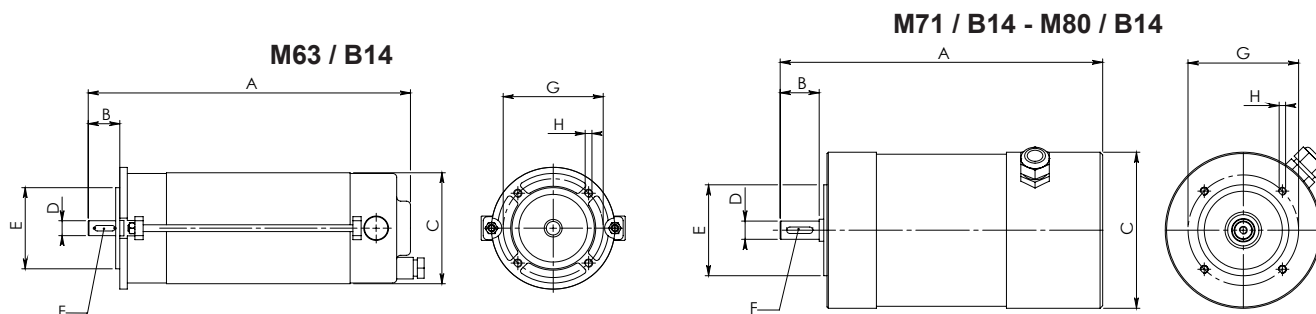

Modello Type	A	B	C	D	E	F	G	H	Peso Weight (kg)
M63.H50 / B14	200	23	80	11	60	4x15	75	M5	3
M63.H75 / B14	225	23	80	11	60	4x15	75	M5	3,5
M63.H100 / B14	250	23	80	11	60	4x15	75	M5	4
M71.H70 / B14	250	30	117	14	70	5x20	85	M6	7
M71.H100 / B14	300	30	117	14	70	5x20	85	M6	9
M71.H120 / B14	300	30	117	14	70	5x20	85	M6	10
M80.H100 / B14	300	40	117	19	80	6x30	100	M6	9,5
M80.H120 / B14	300	40	117	19	80	6x30	100	M6	10,5
M80.H140 / B14	320	40	117	19	80	6x30	100	M6	12

Misure in millimetri (mm), dimensioni non impegnative / Measures in millimeter (mm), dimensions approximated

DIMENSIONI E PESI / DIMENSIONS AND WEIGHTS

M63 / B34

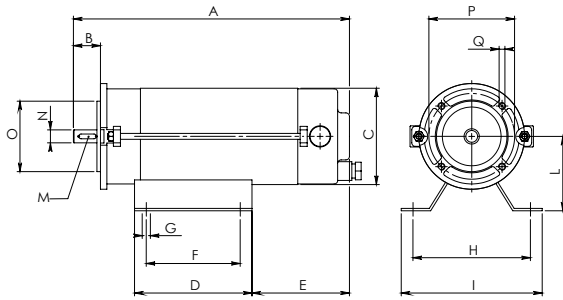

M71 / B34 - M80 / B34

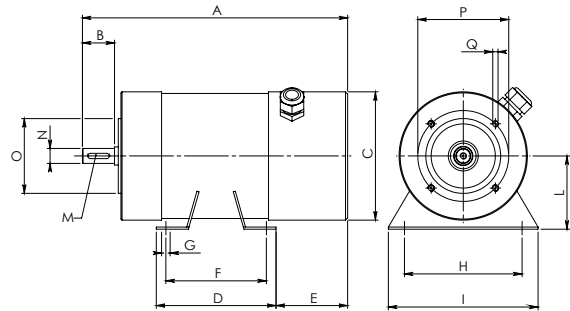

Modello Type	A	B	C	D	E	F	G	H	I	L	M	N	O	P	Q	Peso Weight (kg)
M63.H50 / B34	200	23	80	100	45	80	7	100	120	63	4x15	11	60	75	M5	3
M63.H75 / B34	225	23	80	100	70	80	7	100	120	63	4x15	11	60	75	M5	3,5
M63.H100 / B34	250	23	80	100	95	80	7	100	120	63	4x15	11	60	75	M5	4
M71.H70 / B34	250	30	117	110	70	90	8	112	140	71	5x20	14	70	85	M6	7
M71.H100 / B34	300	30	117	110	120	90	8	112	140	71	5x20	14	70	85	M6	9
M71.H120 / B34	300	30	117	110	120	90	8	112	140	71	5x20	14	70	85	M6	10
M80.H100 / B34	300	40	117	125	120	100	9	125	160	80	6x30	19	80	100	M6	9,5
M80.H120 / B34	300	40	117	125	120	100	9	125	160	80	6x30	19	80	100	M6	10,5
M80.H140 / B34	320	40	117	125	140	100	9	125	160	80	6x30	19	80	100	M6	12

Misure in millimetri (mm), dimensioni non impegnative / Measures in millimeter (mm), dimensions approximated

M63 / B35

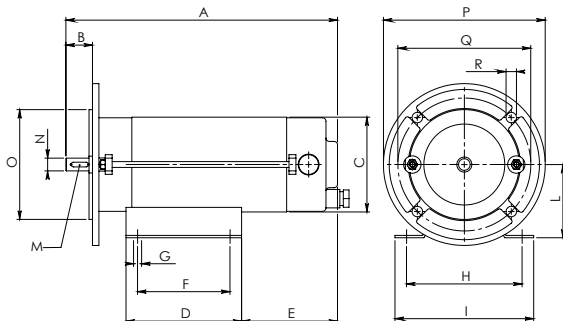

M71 / B35 - M80 / B35

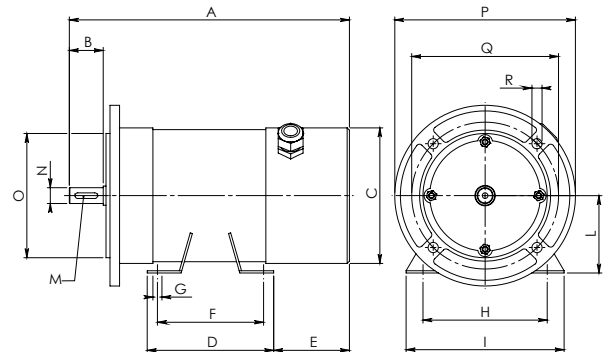

Modello Type	A	B	C	D	E	F	G	H	I	L	M	N	O	P	Q	R	Peso Weight (kg)
M63.H50 / B35	200	23	80	100	45	80	7	100	120	63	4x15	11	95	140	115	9,5	3
M63.H75 / B35	225	23	80	100	70	80	7	100	120	63	4x15	11	95	140	115	9,5	3,5
M63.H100 / B35	250	23	80	100	95	80	7	100	120	63	4x15	11	95	140	115	9,5	4
M71.H70 / B35	250	30	117	110	70	90	8	112	140	71	5x20	14	110	160	130	9,5	7
M71.H100 / B35	300	30	117	110	120	90	8	112	140	71	5x20	14	110	160	130	9,5	9
M71.H120 / B35	300	30	117	110	120	90	8	112	140	71	5x20	14	110	160	130	9,5	10
M80.H100 / B35	300	40	117	125	120	100	9	125	160	80	6x30	19	130	200	165	11,5	9,5
M80.H120 / B35	300	40	117	125	120	100	9	125	160	80	6x30	19	130	200	165	11,5	10,5
M80.H140 / B35	320	40	117	125	140	100	9	125	160	80	6x30	19	130	200	165	11,5	12

Misure in millimetri (mm), dimensioni non impegnative / Measures in millimeter (mm), dimensions approximated